

Assembly Instruction

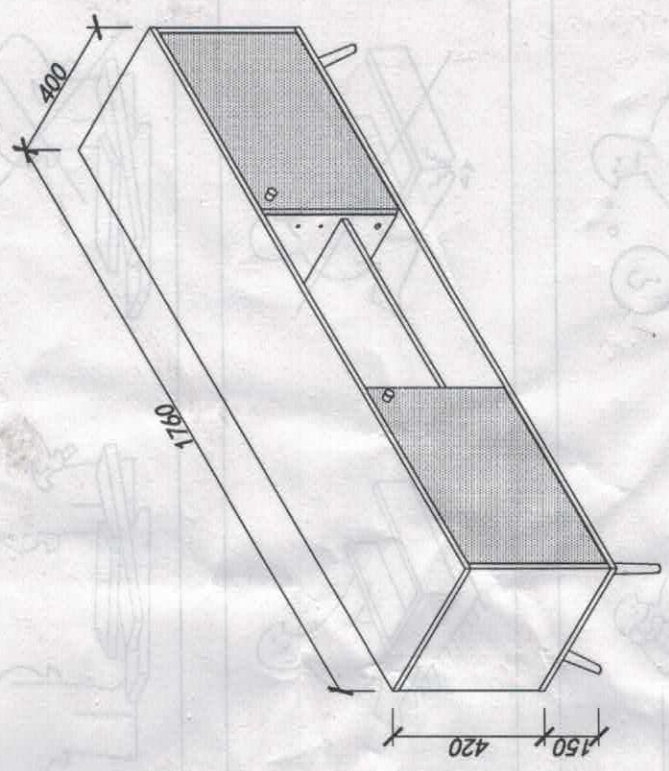

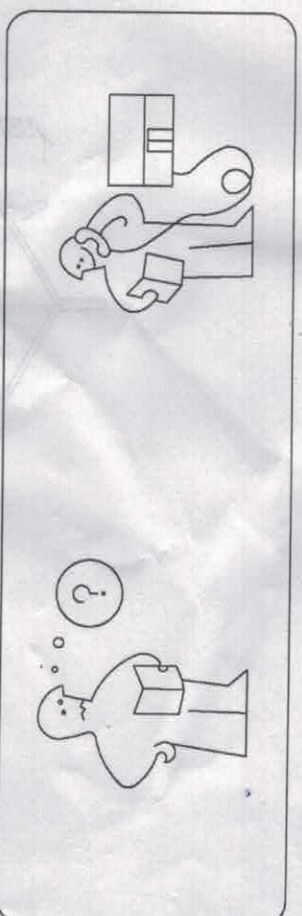

Panel No	Panel Sizes	Quantity
1	1760*400*16	1
2	1760*400*16	1
3	388*399*16	2
4	388*362*16	2
5	555*345*16	2
6	575*345*16	1
7	1736*398*5	1
8	384*570*16	1
9	384*570*16	1

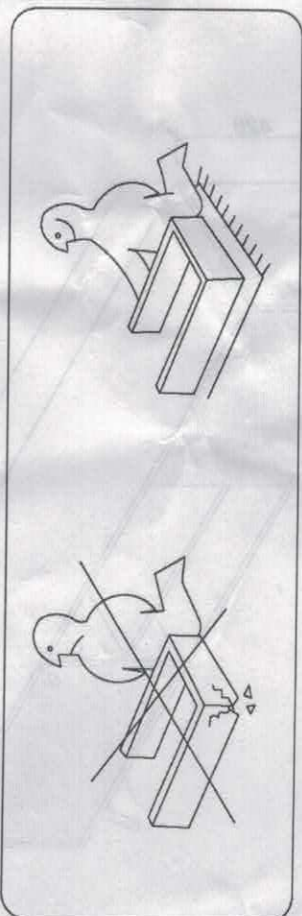
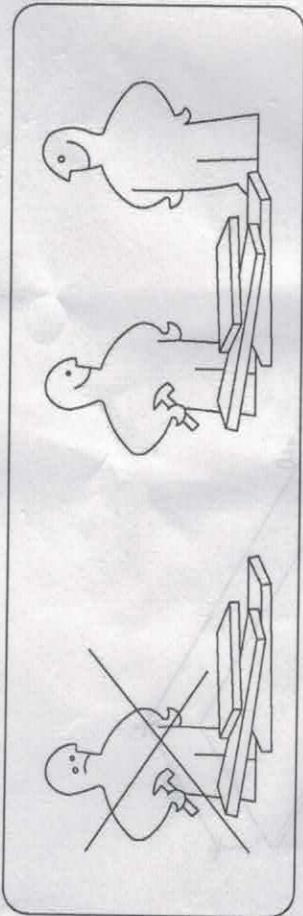
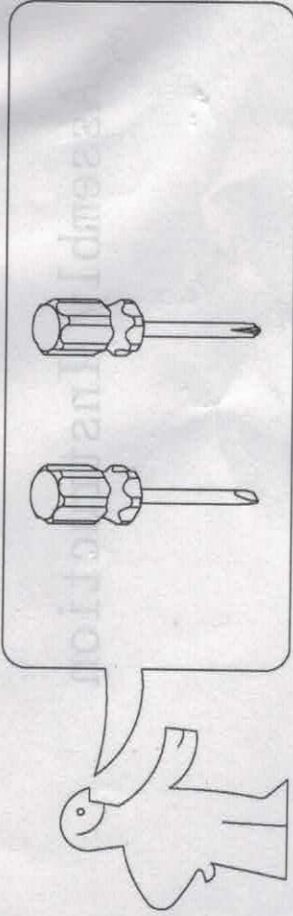
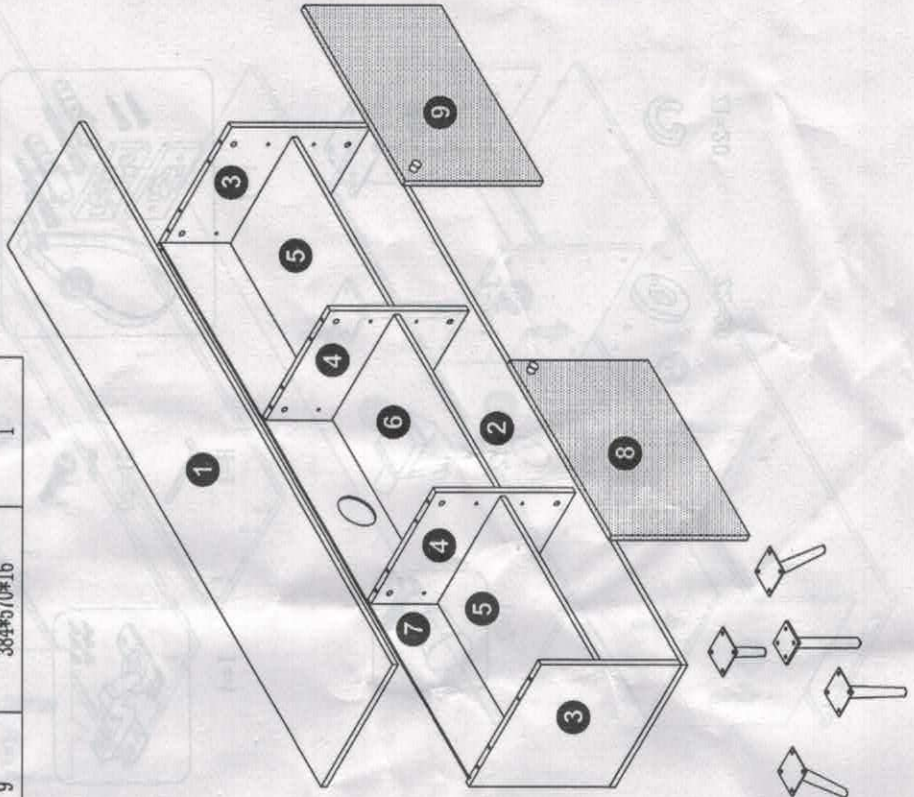

Fittings



A=16



B=16



C=16



D=16



E=8

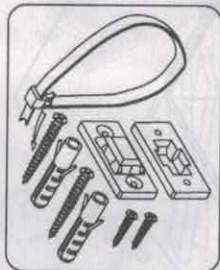

F=1



G1=20



H=1

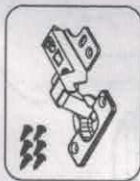

I=4

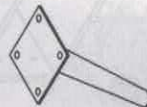

J-1=4



J-2=1



L=12



U=2



Z1=20



Z2=20

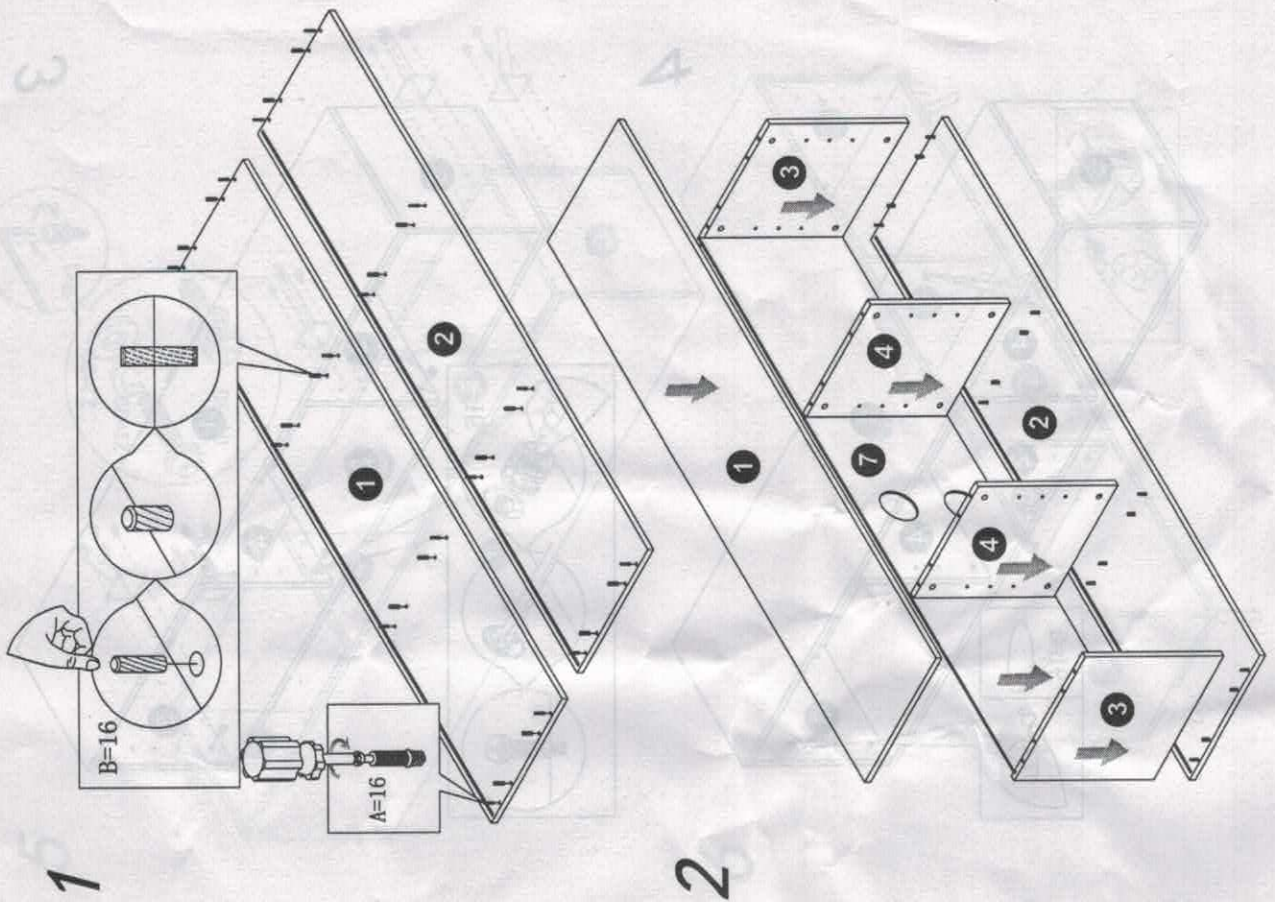

1

2

3

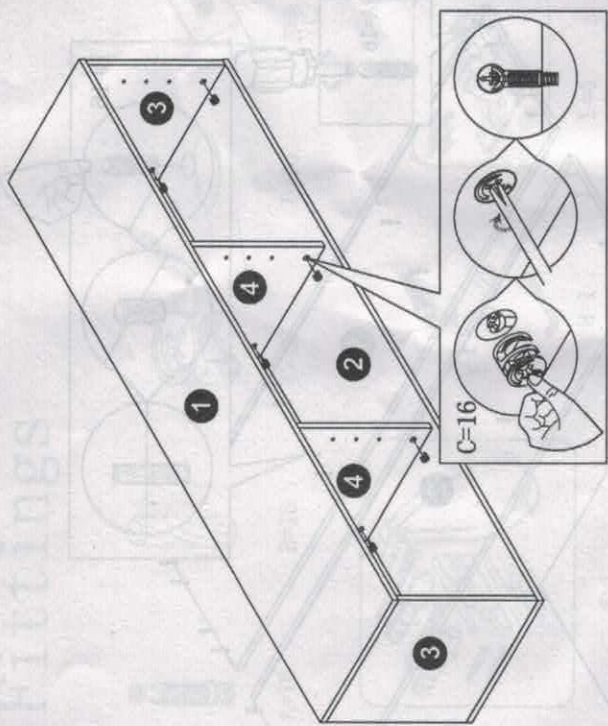

4

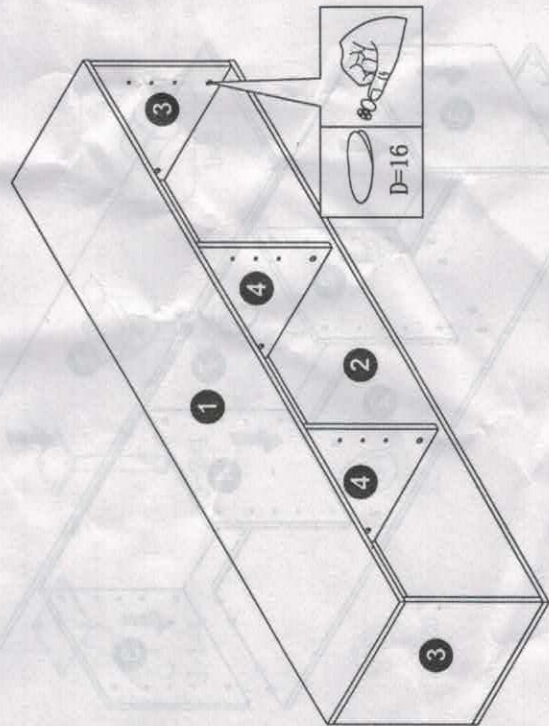

5

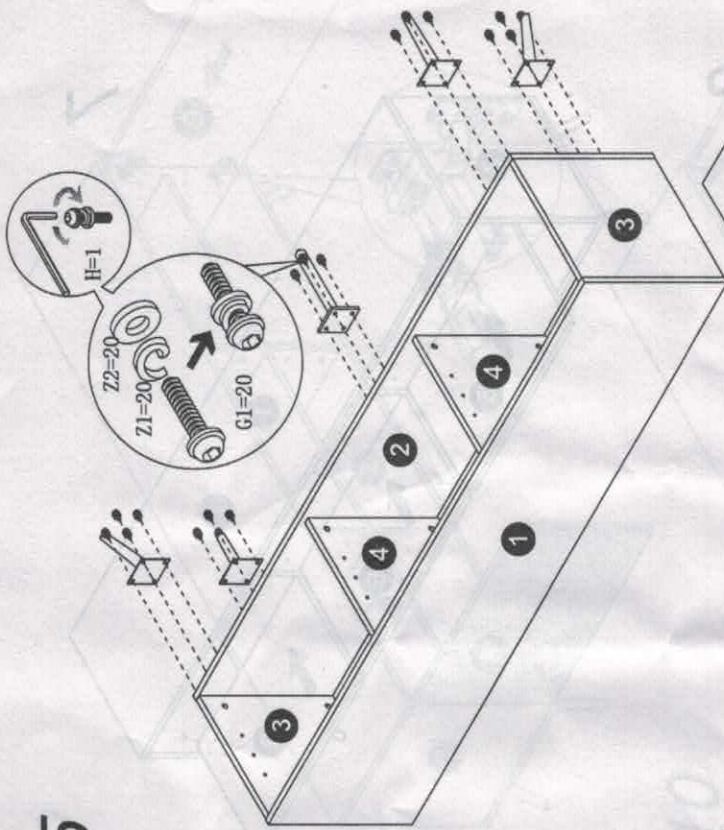

6

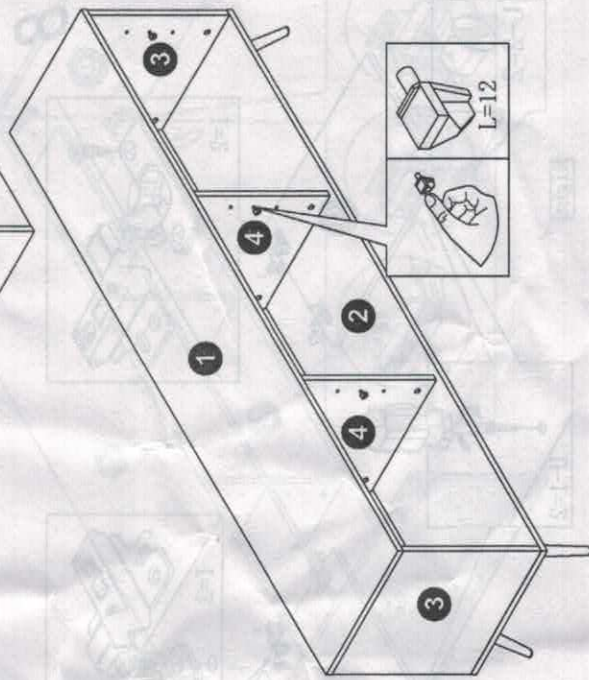

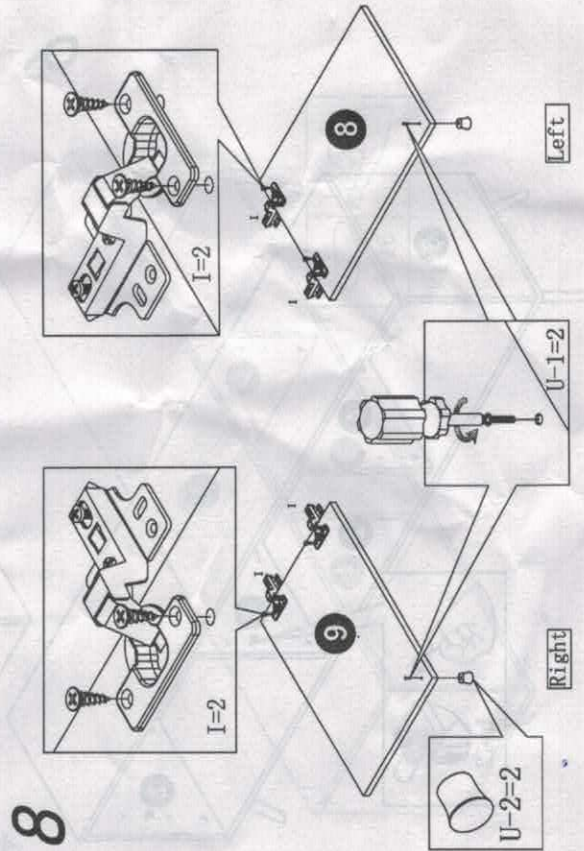
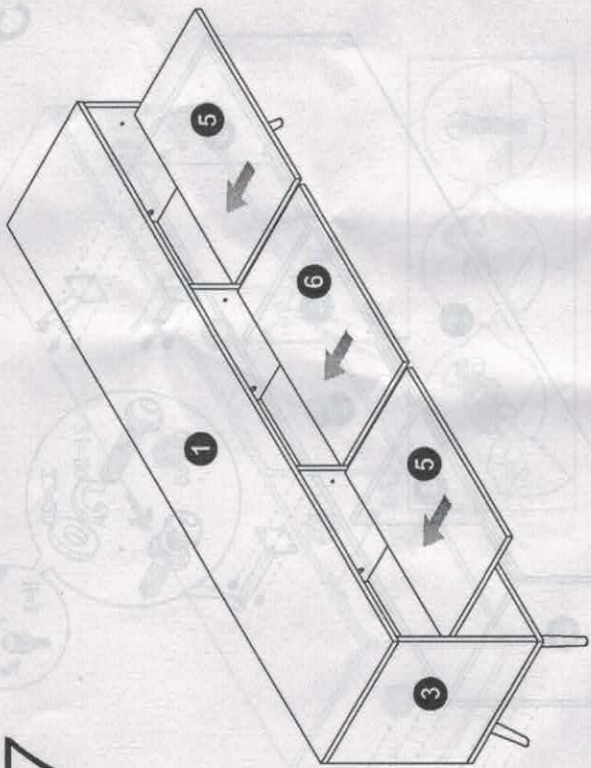
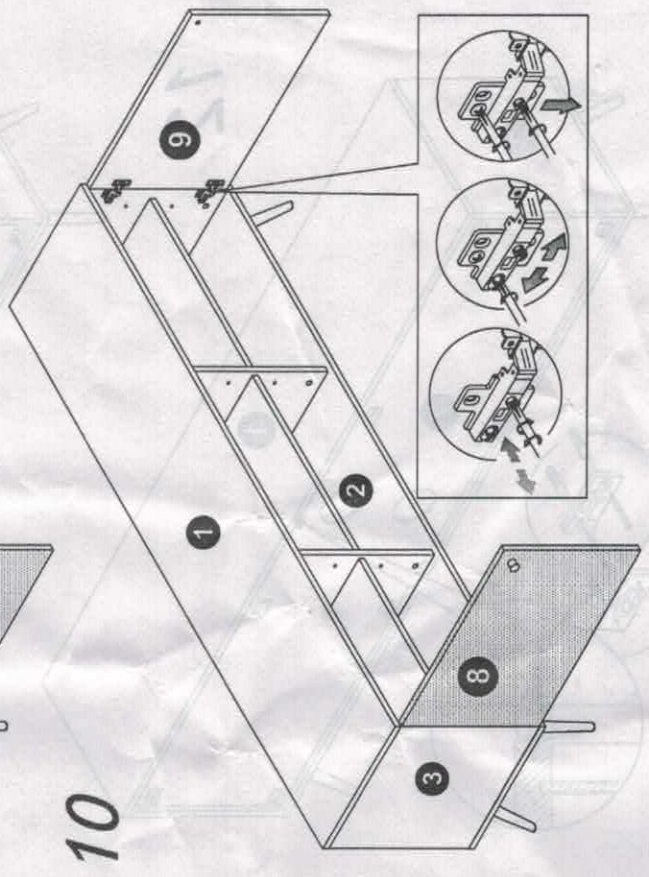
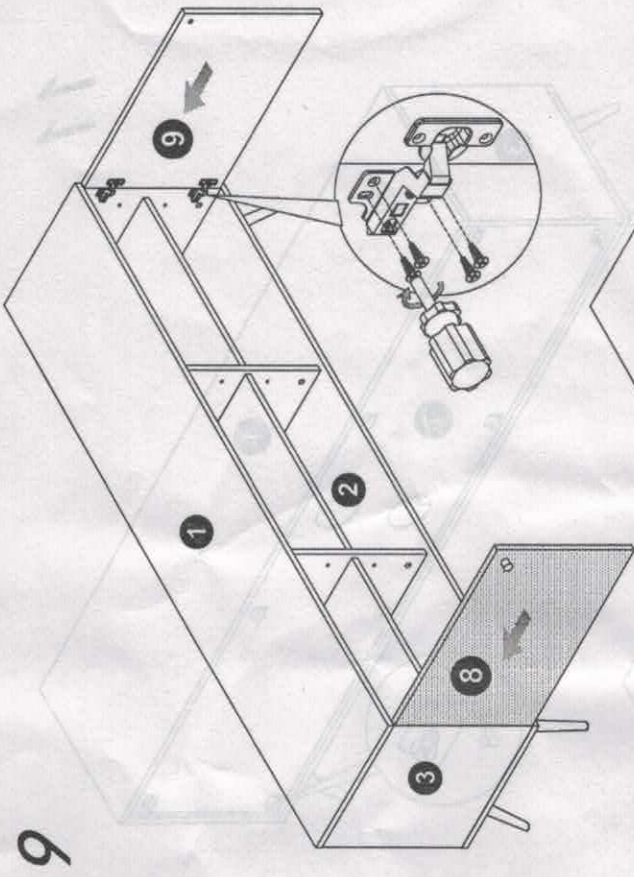

11

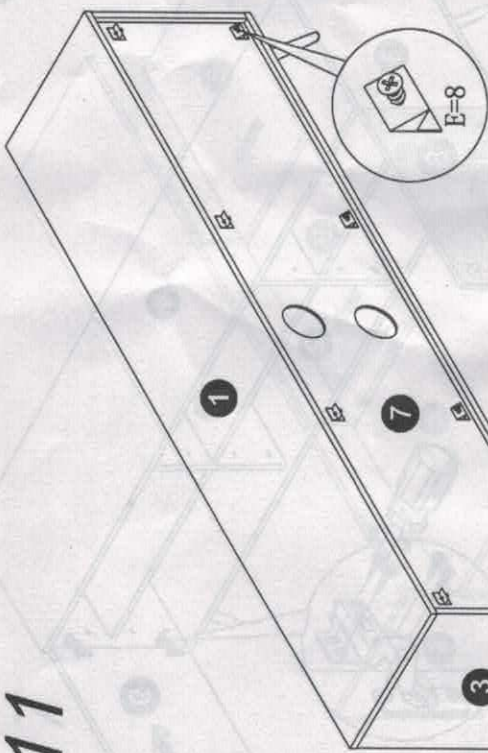

12

